

MTD6N15

Power Field Effect Transistor DPAK for Surface Mount N-Channel Enhancement-Mode Silicon Gate

This TMOS Power FET is designed for high speed, low loss power switching applications such as switching regulators, converters, solenoid and relay drivers.

Features

- Silicon Gate for Fast Switching Speeds
- Low $R_{DS(on)}$ — 0.3 Ω Max
- Rugged — SOA is Power Dissipation Limited
- Source-to-Drain Diode Characterized for Use With Inductive Loads
- Low Drive Requirement — $V_{GS(th)} = 4.0$ V Max
- Surface Mount Package on 16 mm Tape
- Pb-Free Package is Available

MAXIMUM RATINGS

Rating	Symbol	Value	Unit
Drain-Source Voltage	V_{DSS}	150	Vdc
Drain-Gate Voltage ($R_{GS} = 1.0$ M Ω)	V_{DGR}	150	Vdc
Gate-Source Voltage	V_{GS}	± 20	Vdc
– Continuous	V_{GSM}	± 40	Vpk
– Non-Repetitive ($t_p \leq 50$ μ s)			
Drain Current – Continuous	I_D	6.0	Adc
– Pulsed	I_{DM}	20	
Total Power Dissipation @ $T_C = 25^\circ\text{C}$ Derate above 25°C	P_D	20 0.16	W W/ $^\circ\text{C}$
Total Power Dissipation @ $T_A = 25^\circ\text{C}$ Derate above 25°C (Note 1)	P_D	1.25 0.01	W W/ $^\circ\text{C}$
Total Power Dissipation @ $T_A = 25^\circ\text{C}$ (Note 1) Derate above 25°C (Note 2)	P_D	1.75 0.014	W W/ $^\circ\text{C}$
Operating and Storage Junction Temperature Range	T_J, T_{stg}	-65 to +150	$^\circ\text{C}$

THERMAL CHARACTERISTICS

Characteristic	Symbol	Value	Unit
Thermal Resistance			$^\circ\text{C}/\text{W}$
– Junction-to-Case	$R_{\theta JC}$	6.25	
– Junction-to-Ambient (Note 1)	$R_{\theta JA}$	100	
– Junction-to-Ambient (Note 2)	$R_{\theta JA}$	71.4	

Stresses exceeding Maximum Ratings may damage the device. Maximum Ratings are stress ratings only. Functional operation above the Recommended Operating Conditions is not implied. Extended exposure to stresses above the Recommended Operating Conditions may affect device reliability.

1. When surface mounted to an FR4 board using the minimum recommended pad size.
2. When surface mounted to an FR4 board using 0.5 sq. in. drain pad size.



ON Semiconductor®

<http://onsemi.com>

$V_{(BR)DSS}$	$R_{DS(on)}$ MAX	I_D MAX
150 V	0.3 Ω	6.0 A

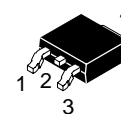
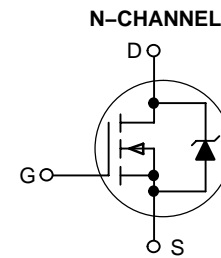

CASE 369C
DPAK
(Surface Mount)
STYLE 2

MARKING DIAGRAM & PIN ASSIGNMENTS

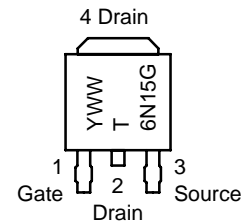

Y = Year
WW = Work Week
6N15 = Device Code
G = Pb-Free Package

ORDERING INFORMATION

Device	Package	Shipping†
MTD6N15T4	DPAK	2500/Tape & Reel
MTD6N15T4G	DPAK (Pb-Free)	2500/Tape & Reel

†For information on tape and reel specifications, including part orientation and tape sizes, please refer to our Tape and Reel Packaging Specification Brochure, BRD8011/D.

MTD6N15

ELECTRICAL CHARACTERISTICS (T_J = 25°C unless otherwise noted)

Characteristic	Symbol	Min	Max	Unit
OFF CHARACTERISTICS				
Drain–Source Breakdown Voltage (V _{GS} = 0 Vdc, I _D = 0.25 mAdc)	V _{(BR)DSS}	150	–	Vdc
Zero Gate Voltage Drain Current (V _{DS} = Rated V _{DSS} , V _{GS} = 0 Vdc) T _J = 125°C	I _{DSS}	–	10 100	μAdc
Gate–Body Leakage Current, Forward (V _{GSF} = 20 Vdc, V _{DS} = 0)	I _{GSSF}	–	100	nAdc
Gate–Body Leakage Current, Reverse (V _{GSR} = 20 Vdc, V _{DS} = 0)	I _{GSSR}	–	100	nAdc

ON CHARACTERISTICS (Note 3)

Gate Threshold Voltage (V _{DS} = V _{GS} , I _D = 1.0 mAdc) T _J = 100°C	V _{GS(th)}	2.0 1.5	4.5 4.0	Vdc
Static Drain–Source On–Resistance (V _{GS} = 10 Vdc, I _D = 3.0 Adc)	R _{DS(on)}	–	0.3	Ω
Drain–Source On–Voltage (V _{GS} = 10 Vdc) (I _D = 6.0 Adc) (I _D = 3.0 Adc, T _J = 100°C)	V _{DS(on)}	–	1.8 1.5	Vdc
Forward Transconductance (V _{DS} = 15 Vdc, I _D = 3.0 Adc)	g _{FS}	2.5	–	mhos

DYNAMIC CHARACTERISTICS

Input Capacitance	(V _{DS} = 25 Vdc, V _{GS} = 0 Vdc, f = 1.0 MHz) (See Figure 11)	C _{iss}	–	1200	pF
Output Capacitance		C _{oss}	–	500	
Reverse Transfer Capacitance		C _{rss}	–	120	

SWITCHING CHARACTERISTICS* (T_J = 100°C)

Turn–On Delay Time	(V _{DD} = 25 Vdc, I _D = 3.0 Adc, R _G = 50 Ω) (See Figures 13 and 14)	t _{d(on)}	–	50	ns
Rise Time		t _r	–	180	
Turn–Off Delay Time		t _{d(off)}	–	200	
Fall Time		t _f	–	100	
Total Gate Charge	(V _{DS} = 0.8 Rated V _{DSS} , I _D = Rated I _D , V _{GS} = 10 Vdc) (See Figure 12)	Q _g	15 (Typ)	30	nC
Gate–Source Charge		Q _{gs}	8.0 (Typ)	–	
Gate–Drain Charge		Q _{gd}	7.0 (Typ)	–	

SOURCE–DRAIN DIODE CHARACTERISTICS*

Forward On–Voltage	(I _S = 6.0 Adc, di/dt = 25 A/μs, V _{GS} = 0 Vdc)	V _{SD}	1.3 (Typ)	2.0	Vdc
Forward Turn–On Time		t _{on}	Limited by stray inductance		
Reverse Recovery Time		t _{rr}	325 (Typ)	–	ns

3. Pulse Test: Pulse Width ≤ 300 μs, Duty Cycle ≤ 2%.

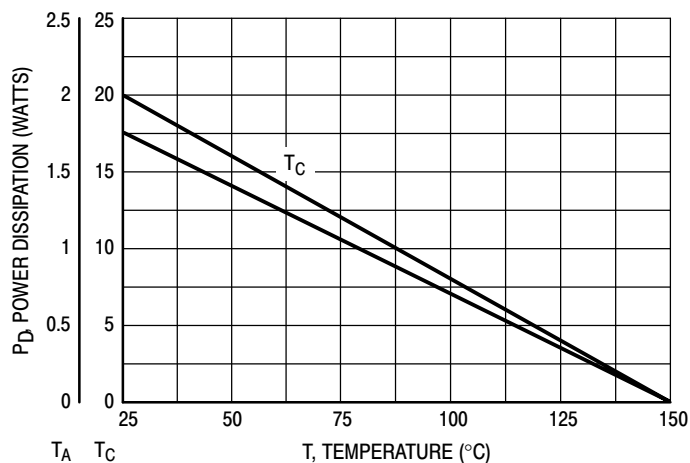

Figure 1. Power Derating

MTD6N15

TYPICAL ELECTRICAL CHARACTERISTICS

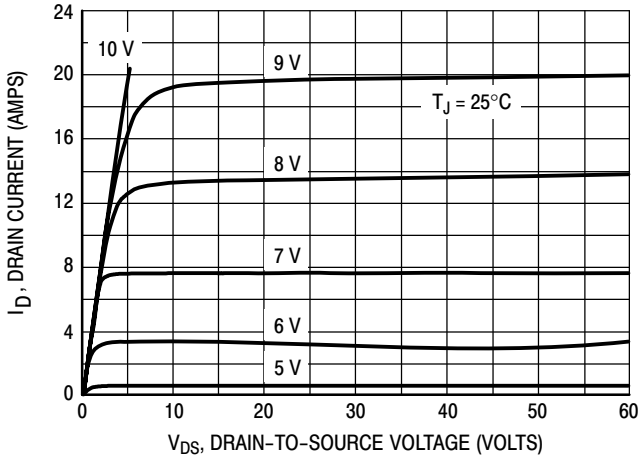

Figure 2. On-Region Characteristics

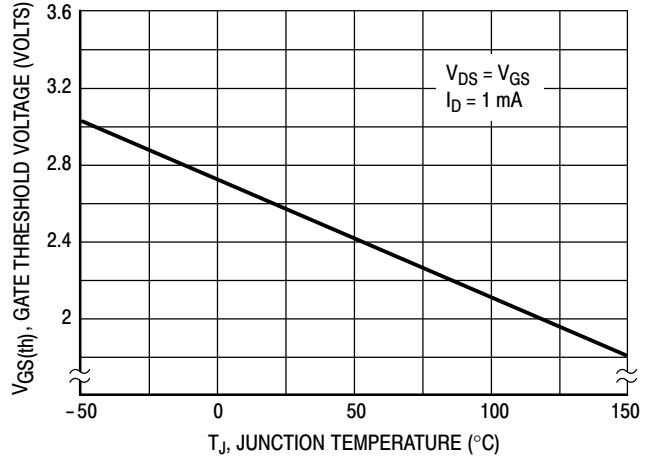

Figure 3. Gate-Threshold Voltage Variation With Temperature

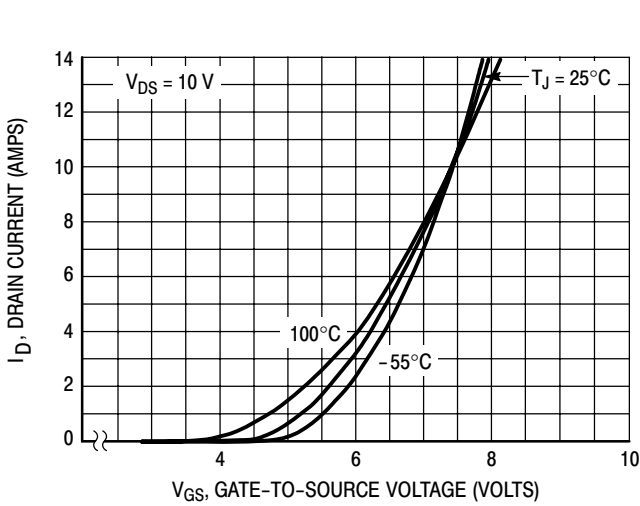

Figure 4. Transfer Characteristics

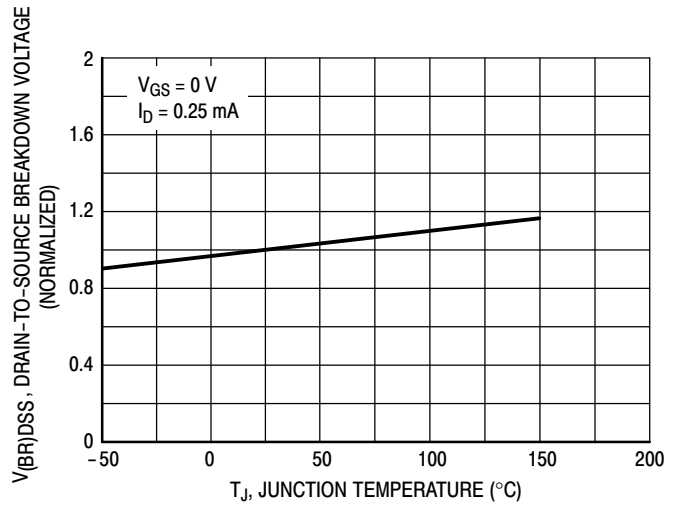

Figure 5. Breakdown Voltage Variation With Temperature

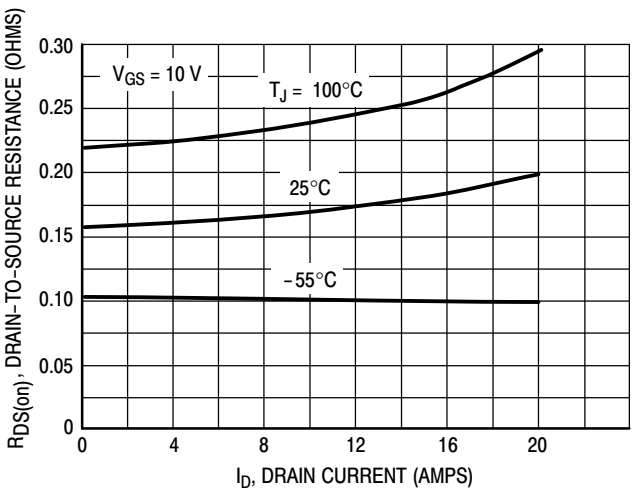

Figure 6. On-Resistance versus Drain Current

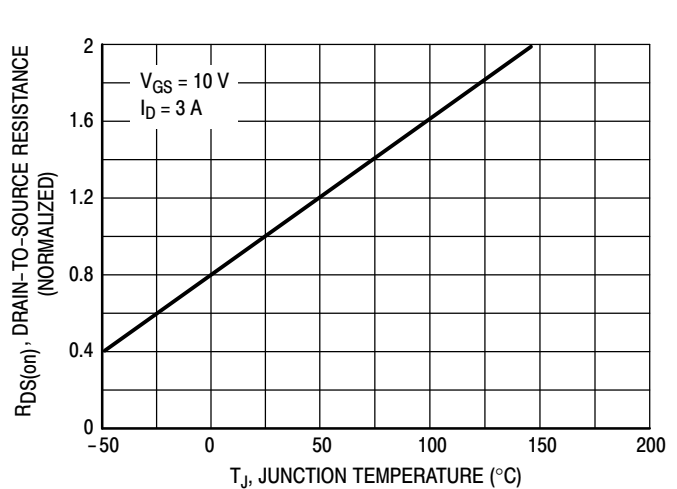

Figure 7. On-Resistance Variation With Temperature

SAFE OPERATING AREA

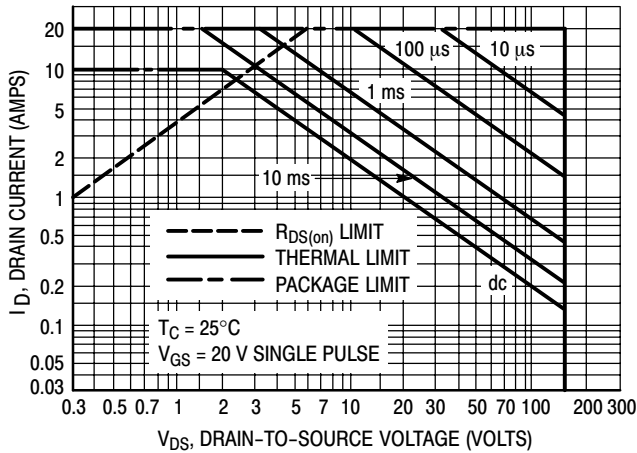

Figure 8. Maximum Rated Forward Biased Safe Operating Area

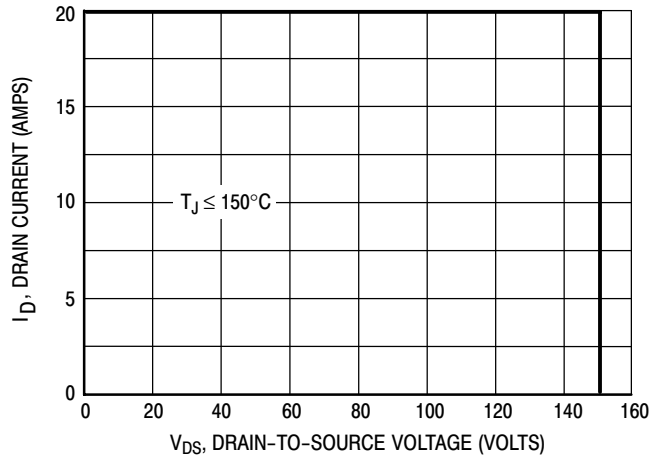

Figure 9. Maximum Rated Switching Safe Operating Area

FORWARD BIASED SAFE OPERATING AREA

The FBSOA curves define the maximum drain-to-source voltage and drain current that a device can safely handle when it is forward biased, or when it is on, or being turned on. Because these curves include the limitations of simultaneous high voltage and high current, up to the rating of the device, they are especially useful to designers of linear systems. The curves are based on a case temperature of 25°C and a maximum junction temperature of 150°C. Limitations for repetitive pulses at various case temperatures can be determined by using the thermal response curves. Motorola Application Note, AN569, "Transient Thermal Resistance-General Data and Its Use" provides detailed instructions.

SWITCHING SAFE OPERATING AREA

The switching safe operating area (SOA) of Figure 9 is the boundary that the load line may traverse without incurring damage to the MOSFET. The fundamental limits are the peak current, I_{DM} and the breakdown voltage, $V_{(BR)DSS}$. The switching SOA shown in Figure 8 is applicable for both turn-on and turn-off of the devices for switching times less than one microsecond.

The power averaged over a complete switching cycle must be less than:

$$\frac{T_{J(max)} - T_C}{R_{\theta JC}}$$

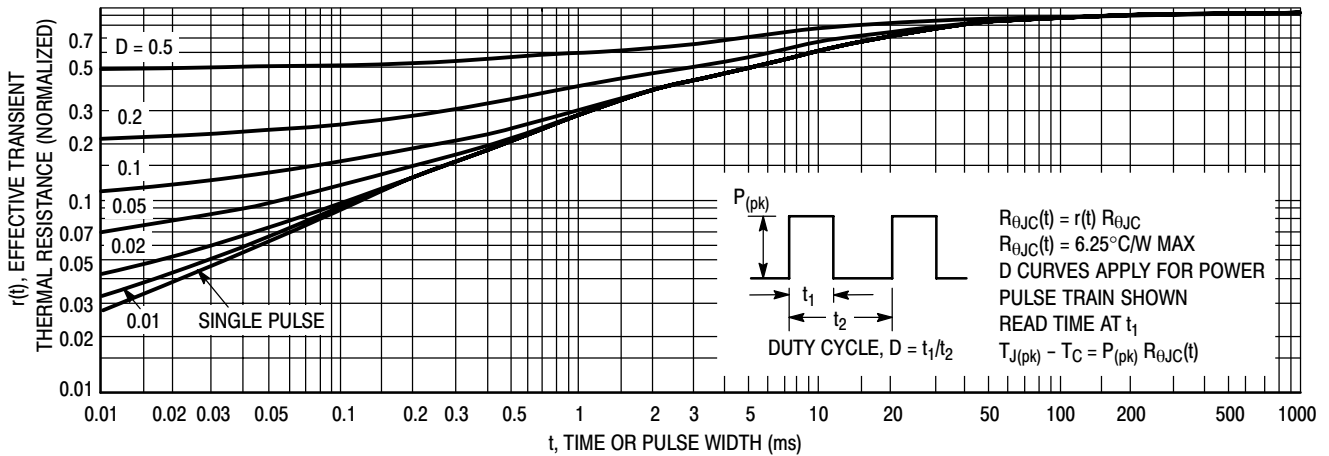

Figure 10. Thermal Response

MTD6N15

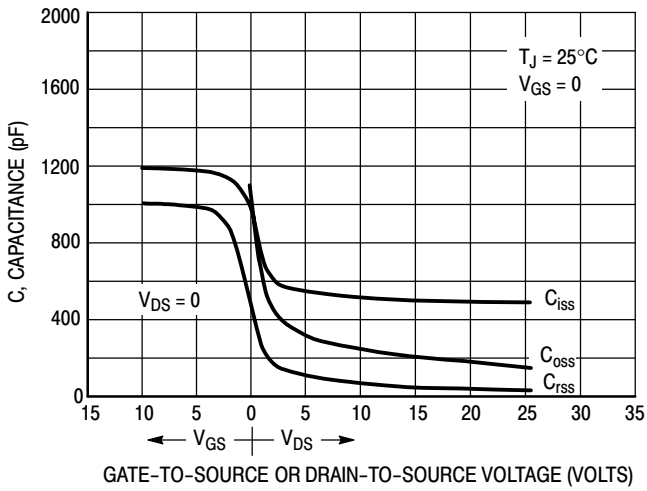

Figure 11. Capacitance Variation

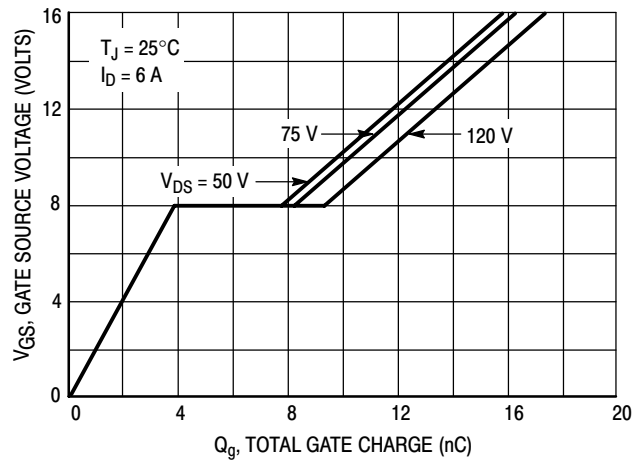

Figure 12. Gate Charge versus Gate-To-Source Voltage

RESISTIVE SWITCHING

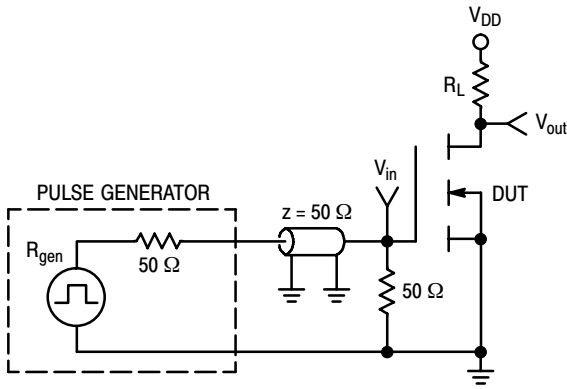

Figure 13. Switching Test Circuit

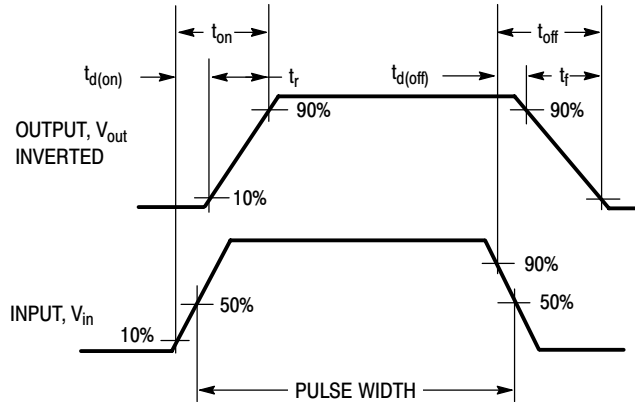
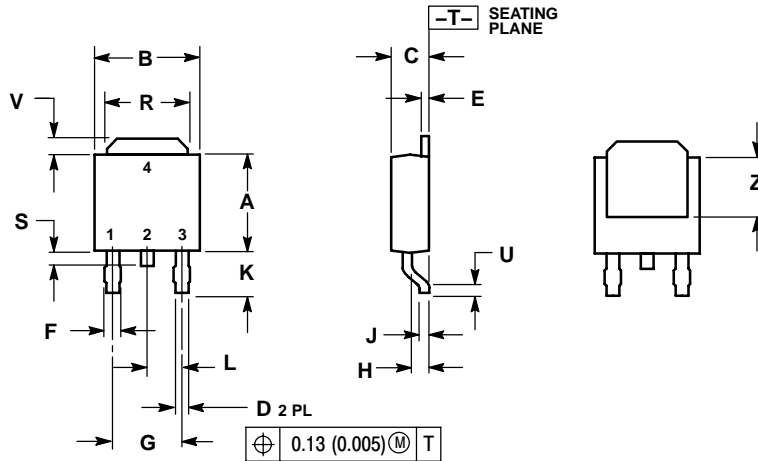

Figure 14. Switching Waveforms

MTD6N15

PACKAGE DIMENSIONS

DPAK
CASE 369C-01
ISSUE O



NOTES:
1. DIMENSIONING AND TOLERANCING PER ANSI Y14.5M, 1982.
2. CONTROLLING DIMENSION: INCH.

DIM	INCHES		MILLIMETERS	
	MIN	MAX	MIN	MAX
A	0.235	0.245	5.97	6.22
B	0.250	0.265	6.35	6.73
C	0.086	0.094	2.19	2.38
D	0.027	0.035	0.69	0.88
E	0.018	0.023	0.46	0.58
F	0.037	0.045	0.94	1.14
G	0.180	BSC	4.58	BSC
H	0.034	0.040	0.87	1.01
J	0.018	0.023	0.46	0.58
K	0.102	0.114	2.60	2.89
L	0.090	BSC	2.29	BSC
R	0.180	0.215	4.57	5.45
S	0.025	0.040	0.63	1.01
U	0.020	---	0.51	---
V	0.035	0.050	0.89	1.27
Z	0.155	---	3.93	---

STYLE 2:
PIN 1. GATE
2. DRAIN
3. SOURCE
4. DRAIN

SOLDERING FOOTPRINT*

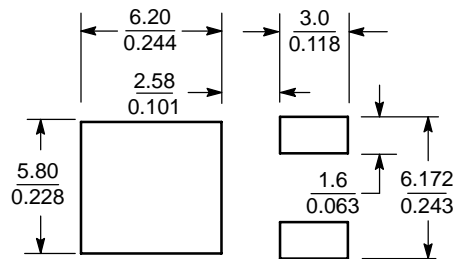

SCALE 3:1 $\left(\frac{\text{mm}}{\text{inches}}\right)$

*For additional information on our Pb-Free strategy and soldering details, please download the ON Semiconductor Soldering and Mounting Techniques Reference Manual, SOLDERRM/D.

ON Semiconductor and  are registered trademarks of Semiconductor Components Industries, LLC (SCILLC). SCILLC reserves the right to make changes without further notice to any products herein. SCILLC makes no warranty, representation or guarantee regarding the suitability of its products for any particular purpose, nor does SCILLC assume any liability arising out of the application or use of any product or circuit, and specifically disclaims any and all liability, including without limitation special, consequential or incidental damages. "Typical" parameters which may be provided in SCILLC data sheets and/or specifications can and do vary in different applications and actual performance may vary over time. All operating parameters, including "Typicals" must be validated for each customer application by customer's technical experts. SCILLC does not convey any license under its patent rights nor the rights of others. SCILLC products are not designed, intended, or authorized for use as components in systems intended for surgical implant into the body, or other applications intended to support or sustain life, or for any other application in which the failure of the SCILLC product could create a situation where personal injury or death may occur. Should Buyer purchase or use SCILLC products for any such unintended or unauthorized application, Buyer shall indemnify and hold SCILLC and its officers, employees, subsidiaries, affiliates, and distributors harmless against all claims, costs, damages, and expenses, and reasonable attorney fees arising out of, directly or indirectly, any claim of personal injury or death associated with such unintended or unauthorized use, even if such claim alleges that SCILLC was negligent regarding the design or manufacture of the part. SCILLC is an Equal Opportunity/Affirmative Action Employer. This literature is subject to all applicable copyright laws and is not for resale in any manner.

PUBLICATION ORDERING INFORMATION

LITERATURE FULFILLMENT:
Literature Distribution Center for ON Semiconductor
P.O. Box 5163, Denver, Colorado 80217 USA
Phone: 303-675-2175 or 800-344-3860 Toll Free USA/Canada
Fax: 303-675-2176 or 800-344-3867 Toll Free USA/Canada
Email: orderlit@onsemi.com

N. American Technical Support: 800-282-9855 Toll Free
USA/Canada
Europe, Middle East and Africa Technical Support:
Phone: 421 33 790 2910
Japan Customer Focus Center
Phone: 81-3-5773-3850

ON Semiconductor Website: www.onsemi.com
Order Literature: <http://www.onsemi.com/orderlit>

For additional information, please contact your local Sales Representative